Tetra 3

Personal Multigas Monitor



User Manual

M07655

December 2006
Issue 3

 **CROWCON**
Gas Detection You Can Trust

Safety Certification:

Tetra 3 is classified to both US standards by Underwriter Laboratories and Canadian standards by CSA as suitable for use in Class 1 Groups A, B, C, D. Division I locations. Before use read the manual to ensure a full understanding of how to operate the unit and as to any limitations of use.

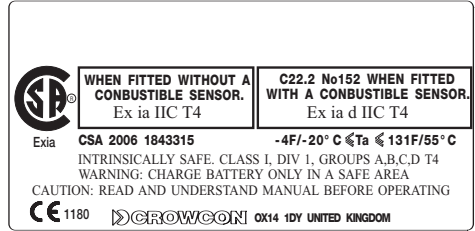
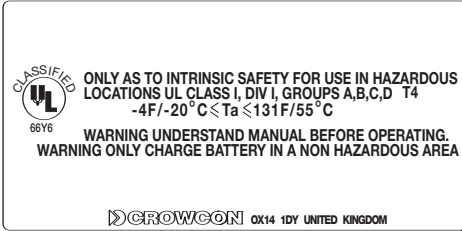

Warning

- To avoid possible personal injury:
- Substitution of components may impair intrinsic safety.
- To prevent ignition of flammable or combustible atmospheres, read, understand, and adhere to the manufacturer's live maintenance instructions.
- The device is not intended for use in atmospheres containing an oxygen concentration greater than 21 percent by volume.
- Do not use the detector if it is damaged or something is missing, contact Crowcon immediately.
- Use only sensor modules specifically designed for your Tetra 3. (Please see the section on replacement parts and accessories.)
- Periodically, "bump test" the sensor with gas to confirm its ability to respond to gas by exposing the detector to a targetted gas concentration that exceeds the high alarm setpoint. Manually verify that the audible and visual alarms are activated.
- It is recommended that the detector be calibrated before first-time use, and then at least once every 90 days and only by qualified personnel.
- For use in potentially explosive atmospheres where oxygen concentrations do not exceed 21%(v/v).
- Do not turn off the detector during a work shift. Turning off the detector resets the time weighted average gas exposure values to zero.
- Ensure that the sensor is not blocked.
- Only the combustible gas detection portion of this instrument has been assessed for performance on methane according to C22.2 No.152.
- High off-scale %LEL readings may indicate an explosive concentration.
- Protect the combustible gas sensor from exposure to lead compounds, silicones and chlorinated hydrocarbons. Although certain organic vapors (such as leaded gasoline and halogenated hydrocarbons) may temporarily inhibit sensor performance, in most cases the sensor will recover after calibration.
- It is recommended that the combustible gas sensor be checked with a known concentration of calibration gas after any exposure to catalyst contaminations/poisons (sulfur compounds, silicon vapors, halogenated compounds etc.)

- Only charge battery in a non-hazardous area.
- Only charge the battery using a Crowcon supplied charger.
- Do not use any other charger. Other chargers may damage the detector making it unsafe for use in hazardous areas.
- Do not change or charge batteries in a hazardous location. Doing so may lead to fire or explosion.
- Extended exposure of the combustible sensor to certain concentrations of combustible gases and air may stress the sensor element, which can seriously affect its performance. If an alarm occurs due to a high concentration of combustible gases, recalibration should be performed, or if needed, the sensor replaced.
- Do not test the combustible sensor's response using a butane lighter. Doing so may damage the sensor.
- Prior to each days usage, sensitivity must be tested on a known concentration of methane equivalent to 25-50% of full scale concentration (accuracy must be within -0 to +20% of actual). Accuracy may be corrected by recalibrating the instrument.
- Any rapid up-scale reading followed by a declining or erratic reading may indicate a gas concentration beyond the upper scale limit, which may be hazardous.

Caution

CAUTION: For safety reasons this equipment must be operated and serviced by qualified personnel only. Read and understand instruction manual completely before operating or servicing.

ATTENTION: Pour des raisons de sécurité, cet équipement doit être utilisé, entretenu et réparé uniquement par un personnel qualifié. Étudier le manuel d'instructions en entier avant d'utiliser, d'entretenir ou de réparer l'équipement.

To avoid damage to the detector:

- Do not expose the detector to electrical shock or severe mechanical shock.
- Do not attempt to disassemble, adjust or service the detector unless instructions for that procedure are contained in the manual and/or that part is listed as a replacement part. Only use Crowcon replacement parts.
- Do not immerse the detector in liquids.
- The detector warranty will be voided if customer personnel or third parties damage the detector during repair attempts. Non-Crowcon repair/service attempts void this warranty.

Tetra 3

Personal Multigas Monitor

Contents

Unpacking	1
Quickstart guide	2
Introduction	6
Operation	8
Batteries	12
Alarm indications	13
Fixing accessories	14
Flow sampling	15
Maintenance and calibration.....	20
PC interface and software.....	21
i-module replacement.....	22
Specification	24
Accessories and spare parts	25
Troubleshooting guide	27
Appendix: Limitations of sensors.....	28

Tetra 3

Personal Multigas Monitor

Thank you for purchasing the new Tetra 3 *Personal Multigas Monitor*. Tetra 3 has redefined portable gas monitoring and will give you years of unparalleled service and reliability.

Please read the instructions carefully before use. Keep the manual for future reference.

Unpacking

Remove the Tetra 3 Personal Multigas Monitor from the packaging. The Tetra 3 accessories will be located in the bottom of the box. Check the contents are complete, you should have:

- Tetra 3 unit;
- Charger and power supply;
- A configuration report detailing the sensors installed, alarm settings and a calibration certificate;
- Optional accessories such as aspirator plate, aspirator bulb and comms lead.

Battery check

The Tetra 3 Personal Multigas Monitor has a lithium-ion rechargeable battery. Tetra 3 will operate for a minimum of 16 hours when fully charged.

Tetra 3 uses a Li-ion battery pack and should arrive with sufficient charge so that the unit can be used straight out the box. However, if this is the first time you have used the Tetra 3 unit, you may need to charge the batteries to attain the full 16 hour operating time. The actual operating time will depend on the types of sensors installed.

Warning: rechargeable units

Do not attempt to use any other charger with this unit except the one supplied by Crowcon. Failure to comply could invalidate safety certification and may result in permanent damage to the unit.

Quickstart guide

1. Getting started

Review your Tetra 3 unit

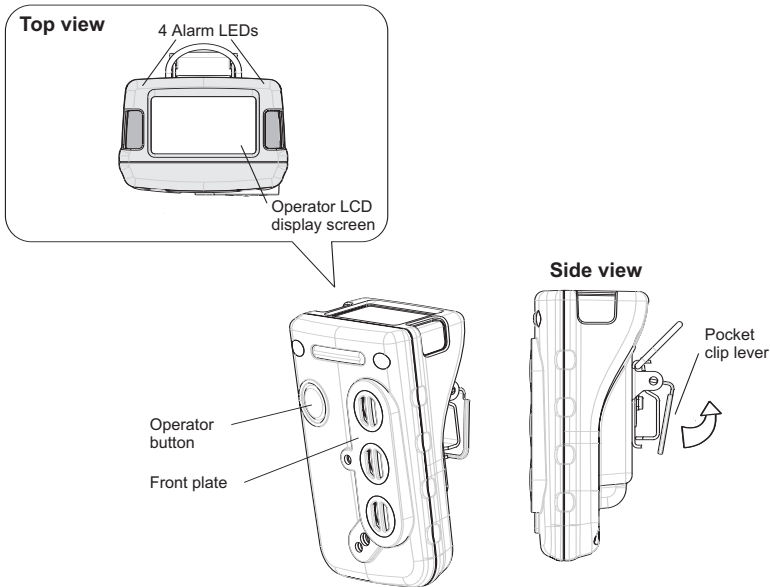

Switching on your unit

Tetra 3 requires little setting up, follow these simple steps to get your unit ready for use.

1. **Ensure the unit is in clean air.**
2. **Switch on**

Press and hold the operator button until the red LED flashes.

The operator display screen will light up and the unit will begin a warm up sequence.

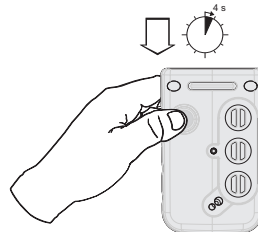

Tetra 3 warm up sequence

a) The unit will test the alarm LEDs, sounder, vibration alerts, and the operator display screen. The sounder may be silenced by pressing the button.

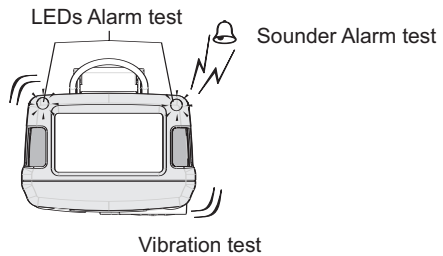

b) The unit will continue through a warm up sequence as shown below, this will take approximately 45 seconds.

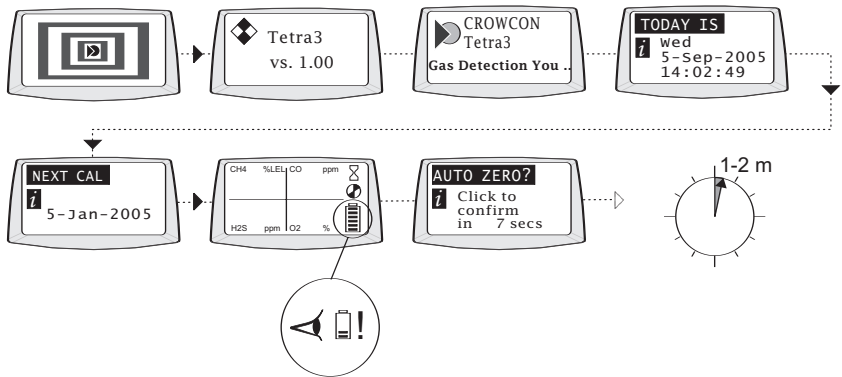

c) Auto zero

If auto zero is enabled (default), the unit will display the auto zero menu. Press the operator button with a single click to confirm auto zero. If the operator button is not pressed within the 10 second time out, Tetra 3 will proceed directly to Run mode without performing zero.

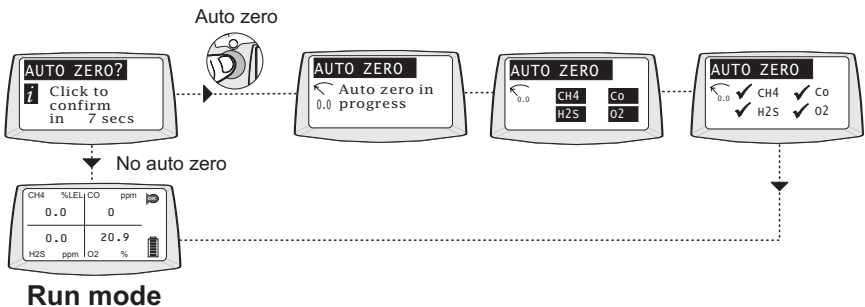



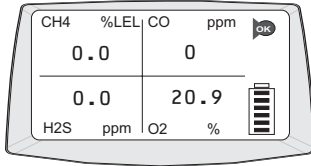

Run mode

Your unit is now ready to use. Below is a typical screen display showing the unit in normal gas monitoring Run mode.



Familiarize yourself with the gases being monitored in your unit and make sure you understand site health and safety procedures in the event of alarm conditions.

Screen Icons

-  Warm up
-  Flashing OK icon, Tetra3 running normally
-  Battery
-  Auto zero

Confidence signals

In normal Run mode, Tetra 3 will emit a short beep every 10 seconds and the OK icon flashes to show operational health.

2. In the event of an alarm

Alarm signals

In the event of gas concentrations exceeding the alarm thresholds for any gas being monitored, Tetra 3 will activate the alarm signals.

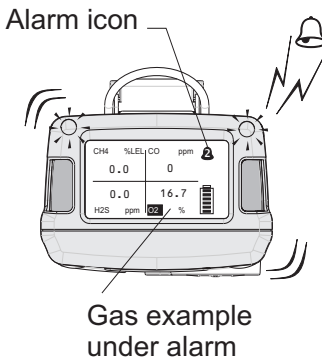

Alarm signals

The red and blue alarm LEDs will flash, the sounder will emit a loud, fast series of beeps, the internal vibrator alarm will activate. The operator screen will display the gas in alarm and the alarm level. See the figure to the left.

1. When the gas level returns to normal, press the operator button. This will reset your Tetra 3 unit to normal Run mode. If gas levels are still in alarm, the button will have no effect.

For any one gas, there are normally two alarm thresholds. These are indicated by the alarm icons shown.



The Tetra 3 alarm is set to latch by default. The unit will still continue in alarm mode even when gas levels return to normal, until the alarm is cleared, by pressing the operator button.

3. Switch off unit and storage

Switching off unit

1. Press and hold the button for 5 seconds. The shut down menu appears, continue to hold button until the unit counts down to shut off.

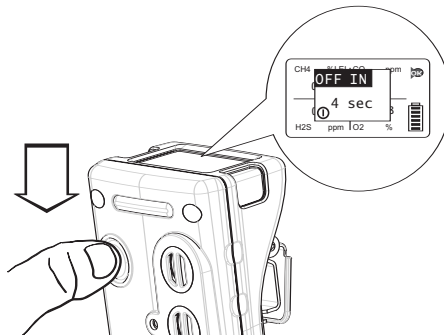

Storing conditions

In order to optimize sensor performance and lifetime, your Tetra 3 unit should be stored in a safe, non-hazardous area, 0-30°C, 10-90%RH.

4. Additional information

- For battery recharging information go to section III.
- For fixing accessories go to section V.
- For sampling section go to section VI.
- For calibration information go to section VII.
- For troubleshooting guide go to section XII.

I. Introduction

Thank you for purchasing the new *Tetra 3 Personal Multigas Monitor*. Tetra 3 is a portable multigas detector, designed to be carried or worn by individuals working in hazardous environments such as confined spaces. It is suitable for use in Division 1 and 2 hazardous areas. Tetra 3 can monitor up to four different gases and display the readings simultaneously on a display screen. Alarm warnings are given through a combination of a loud audible alarm, a bright visual alarm of blue/red flashing LEDs and an internal vibrator. Tetra 3 is fitted with modular, plug and play gas sensors. Each sensor carries an intelligent processor which contains calibration and sensor information.

Tetra 3 is operated using a Lithium-ion rechargeable battery. A charger is available with a range of options.

At Crowcon we recognized the need for a reliable and robust personal monitoring system, which is both lightweight, compact, easy to use and cost effective. Tetra 3 has a single operator button, and an intelligent user-friendly display with backlight. Gas levels are continuously monitored providing normal gas readings, peak readings and time weighted averages (TWA). Tetra 3 is a diffusion sampling instrument with an option to use a hand-operated aspirator. Configuration and data/event logging is handled by Crowcon Portables PC software, the PC communication link being provided through the charger.

Tetra 3's shape and design makes it comfortable to wear and as non-intrusive as possible, with a non-slip grip for better handling. Extra accessories, such as shoulder strap and chest harness, can be purchased.

Tetra 3 has been designed from top to bottom to bring you ease of use, low maintenance and extremely high reliability. Through an innovative and rigorous design process, we have combined several features from our reliable Tetra and Gasman products to produce the new Tetra 3.

i-module gas sensor

Tetra 3 uses unique plug and play i-module sensor technology. Each sensor unit incorporates its own intelligent processor holding sensor configuration and calibration data. Different sensor modules can be purchased, and once inserted, are immediately ready to run. Tetra 3 can operate with up to three sensors and display simultaneously, information and gas readings, for all the sensors, on one screen. This means no redundancy and assured future investment in your Tetra 3 unit, allowing you to swap sensors between units or configure your unit, as

appropriate, to your current needs. Plug and play will ease maintenance time and cost, and the intelligent modular system will remove the need to calibrate each sensor. Additional i-modules can be purchased, pre-calibrated from your local supplier.

Reliable, anti-shock mechanics and robust housing

The Tetra 3 housing is built from resilient material, giving it strength and flexibility to withstand the hardest of working conditions, water and dust tight to IP65 and IP67, and with a non-slip grip. The case has been carefully designed to make servicing easy and at the same time very rugged. If the unit is dropped, there will be no disruption of power or function, ensuring reliability and service for years to come.

Software

The processes used to design and develop the Tetra 3 software ensure a high degree of reliability and robustness. Thus Tetra 3 has been designed to be a truly reliable personal gas monitoring system. The internal circuitry includes an external watchdog, where the software monitors for any malfunction within the unit and will display an error warning to the user should they occur.

II. Operation

2.1 Switch-on sequence

1. **Ensure the unit is in clean air.**
2. **Switch on**

Press and hold the operator button until the two red LEDs flash.

The instrument begins with testing all the LCD segments on the operator display screen, the red and blue alarm LEDs, sounder and internal vibrator alert for about 5 seconds. The sounder may be silenced by pressing the button. The unit enters a warm up mode and displays a sequence of screens, see page 3 for more details. At the end of warm up, the auto zero menu will be displayed.

The auto zero function can be disabled or set to run automatically, without user confirmation: auto zero menu will not appear. See section VIII PC Interface and software.



Battery check

Use this time to check there is sufficient charge in the battery pack

NB. During the warm up sequence, the date for next calibration will be displayed. If the date has expired or has passed, the Tetra 3 unit will display a warning message that calibration is due. The instrument can still function, but it is strongly recommended the unit is sent for calibration as soon as possible.

Tetra 3 can be set, using the Portables PC software, for the instrument to shut down automatically, if the calibration date is passed, to prevent further operation of the instrument.

3. **Auto zero menu**

Press the operator button with a single click to confirm auto zero. If the operator button is not pressed within 10 seconds, Tetra 3 will proceed directly to Run mode without performing a zero. Combustible and toxic sensors will be set to read zero and the oxygen sensor to read 20.9%.

NB. If auto zero fails, a warning message will be displayed and an 'X' will appear against the sensor that has failed.

Switch off

To switch off the unit, press and hold the operator button for 5 seconds. A shut-down menu 'OFF IN' will appear. Continue to hold button until the unit counts down to shut off.



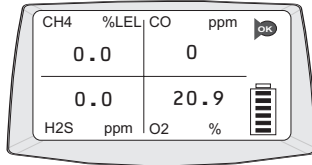

2.2 Run mode

The Tetra 3 unit will display up to four gas readings simultaneously on the operator display screen. A typical four gas display is shown below.



Each channel will display the gas name, units and current value. Familiarize yourself with the gases currently being monitored in your unit. Ensure you understand site health and safety procedures. For information on peak and TWA readings, go to section 2.4.

Screen Icons

-  Warm up
-  Flashing icon, Tetra3 running normally
-  Battery
-  Auto zero

Confidence signals
 To reassure users the unit is working correctly, the Tetra 3 unit will emit a short beep every 10 seconds and the OK icon will flash.

2.3 Display symbol guide



Battery

A full battery is represented by a battery icon showing a full six bars. A low battery charge will show 1 to 2 bars. When zero bars are shown the battery icon flashes. The sounder will emit warning beeps.

If the battery becomes too low, Tetra 3 will display a 'Battery low' warning message and switch off.



TWA alarm

Tetra 3 will display the TWA alarm when the 15 minute or 8 hour time weighted average alarm threshold is passed for toxic gases.

2.4 Display options

Tetra 3 provides two additional selectable displays:

Peak display

When Peak mode is selected the instrument shows the highest value for combustible and toxic gases and the lowest value for oxygen since the unit was switched on or since the last peak clear.

After 5 seconds the screen will display 'Peak Clear'. If you press the button within the 10 second countdown, the peak value is cleared. If the button is not pressed, the display will revert to the stored peak value.

Whilst in Peak mode, new higher gas values are stored. Upon exit of Peak mode, the stored peak values are not deleted.

This is useful for vertical entry checks where a whole instrument can be lowered down the shaft rather than just a sampling tube.

TWA display

Shows the 8 hour time weighted average (TWA), for toxic gases, monitored since last turn on.

1. To view the additional display option menu, double-click the operator button.

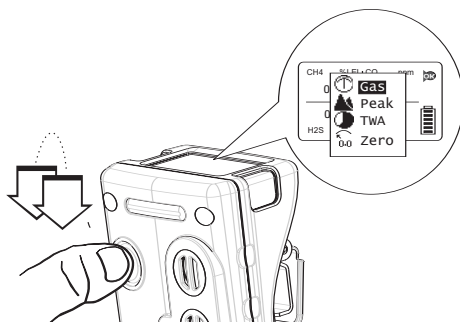

2. Press the operator button with a single click to scroll through the list. When your choice is highlighted, double-click the operator button.

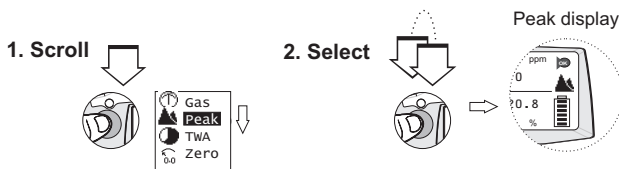

The Tetra 3 operator screen will display the peak or TWA icon and the gas readings recorded.

Zero

The Tetra 3 instrument can perform an auto zero by selecting the Zero function from the menu. When Zero is completed, the instrument will return to normal operation.

2.5 Logging

Tetra 3 incorporates data and event logging which can be accessed using the communications link with Portable PC software. See section VIII.

The Tetra 3 event log records the time and date for a number of operating and diagnostic events including:

- Switch on and switch off
- Level 1, Level 2 and Time Weighted Average Alarms, alarm on, alarm off and the peak level during the alarm
- Zero, calibration and gas test with success or failure
- Catalytic bead saver on and off
- The battery condition is logged every time the Tetra 3 is switched on or off, and when it is placed into or removed from the charger
- Datalogging records reading sets data at a predetermined time interval, usually set to one minute.

III. Batteries

3.1 Rechargeable batteries

Tetra 3 uses a rechargeable Lithium-ion battery which must only be charged using a Crowcon battery charger. A 5 hour recharge from flat will provide at least 12 hours operating time. A fully charged battery will provide more than 16 hours of continuous use.

Charging the batteries

1. Ensure you are in a safe area.
2. Plug the charger power supply into a mains socket.
3. Connect the power supply to the charger. Insert the Tetra 3 into the charger.

Switch on the charger's power supply. The unit would normally be left switched off for charging. When charging is complete the red LED is extinguished. (Early units had a green LED illuminate on completion of charge). If the unit is switched on during charge the normal display battery icon sweeps from empty to full. On disconnecting the charger power supply this display icon will update in 20 seconds to show actual charge state.

In Run mode, the battery icon will display six bars when it is full.

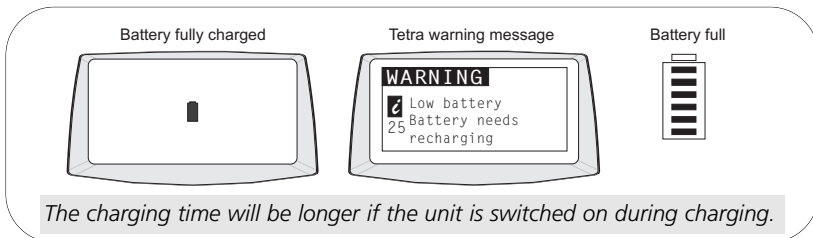
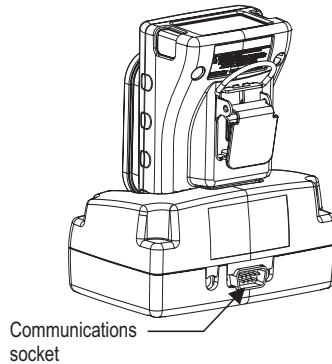

4. Remove the Tetra 3 from the charger and switch on to use.



IV. Alarm indications

Tetra 3 provides two instantaneous alarm levels for each installed sensor, designated level 1 and level 2. For toxic gas sensors, there are also two time weighted average alarms (TWA), one for short term exposure (STEL): based on a 15 minute time weighted average, and the second TWA alarm is for long term exposure: based on a 8 hour time weighted average.

Alarm configurations are set via the Crowcon Portables PC software. The following settings can be made:

Alarm thresholds for each sensor: Level 1 and level 2 alarms can be set for each individual gas sensor.  

Alarm type: This can be set to rising levels of gas concentration, or as falling. Oxygen are set to falling for deficiency monitoring as a default.

Alarm latching: Alarms can be set to be latched or unlatched. Latched alarms will require the operator button to be pushed in order to clear the alarm. This is the default setting. Unlatched alarms will clear automatically when the gas hazard has passed.

Alarm mute: The sounder can be set to mute for level 1 alarm only; pressing the operator button during an alarm condition i.e. presence of hazardous gas, will silence the sounder and stop the vibration alarm. The alarm LEDs will continue to flash.

Alarm sounder tone: Different tones can be selected to achieve the best performance for the monitoring conditions available.

In the event of a Time Weighted Alarm (TWA)



In the event the 15 minute or the 8 hour TWA is triggered, Tetra 3 will go into alarm and display the TWA icon with the toxic gas readings. Neither the 15 minute alarm or 8 hour alarm can be cleared.

V. Fixing Accessories

Belt clip

Tetra 3 has a strong alligator clip located on the back of the unit. Lifting the small lever will allow the unit to be attached to a belt more easily.

Universal harness plate

Crowcon provide a universal harness plate which can be used with either a chest harness or a shoulder strap.

How to wear your Tetra 3 unit

Chest harness

Use the M3 fixing on the back of your Tetra 3 unit to attach the chest harness plate. Create a chest harness by attaching one strap to the top connectors, to go around the neck, and the other to link around the waist using the side connectors. Adjust the lengths until the Tetra 3 unit is in a comfortable working position.

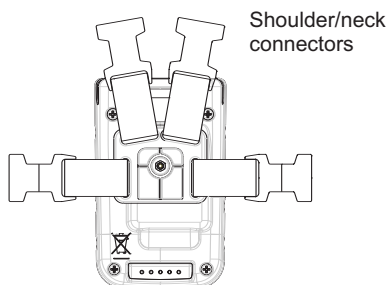

Universal harness plate

Shoulder strap

With the universal harness plate in place, attach the shoulder strap accessory onto the top connectors. Adjust to a comfortable working position. See accessories, section XI, for full list.

VI. Flow sampling

Attaching the flow adaptor plate

To perform manual sampling using Tetra 3, a flow adaptor plate must be fitted onto the front of the instrument.

Flow adaptor

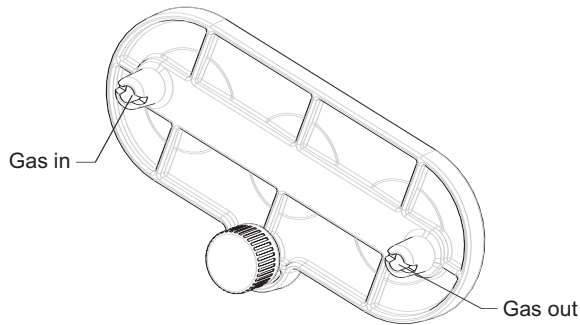

1. To fit the flow adaptor plate, clip the plate in place over the sensor grills and screw the thumbscrew until the plate is tightly fitted into place.
2. Attach the sampling tube or flow accessory onto the gas inlet nozzle.
3. Attach the aspirator bulb onto the gas outlet nozzle.
4. To remove the flow adaptor plate, unscrew the thumbscrew and lift the plate away from the instrument.

The sampling tube supplied is normally a 2m (6ft) length. Longer lengths of sampling tube can be provided, but will increase the time taken to get a sample from the point of sampling to the Tetra 3 instrument. When using an extended length of tubing a response time test is recommended. Gas of known concentration should be sampled along the full length of tubing to be used and the time taken for the sensor reading to reach the known gas levels should be noted. This time should be used as the minimum for sampling before readings should be taken.

Diffusion instruments

When using the manual aspirator kit, adopt a consistent style whilst using the hand aspirator. Crowcon recommend squeezing once per second to achieve a flow rate of approximately 0.5 - 1 litre/min. At least 10 pumps per sample are recommended.

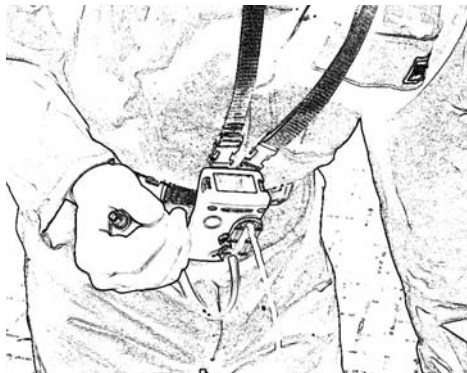

Tetra 3 Bump Test Accessory Kit

The Bump Test Accessory is a gas testing kit designed to enable gas testing of the Tetra 3 multigas detector using a specially formulated, high stability long life quad gas mix. It can be used with Tetra 3 units having sensors for Combustible, Oxygen, Carbon Monoxide and Hydrogen Sulphide gases, and all Tetra 3 units with these sensors can be bump tested using the kit.

6.1 Bump testing

Bump testing checks the sensor is responding within set limits to an applied gas of known composition. This can be performed as often as desired, but would usually be carried out each time the Tetra 3 is issued for use. The Tetra 3 itself will determine Pass/Fail status for the bump test.

In order to perform successful bump tests ensure:

- The quad gas mixture used has the correct gas concentration, and that it is within the validity date specified by the supplier.
- The gas flow path is leak tight. It is important to check that the flow plate is properly fitted to the Tetra 3, and the outlet tubing is not restricted in any way, nor additional tubing length used.

The Bump Test Accessory Kit comprises; a gas cylinder containing the quad gas mix, a 'Trigger' regulator with interconnect tubing, a magnet - used to activate Test mode, an aspirator plate to attach to the Tetra 3 and a vent line. The Trigger regulator can be operated in two ways: (1) squeeze and hold - allows gas flow as long as the lever is held in, or (2) by lifting the lever - the flow is locked on.

6.2 How to perform a gas test

1. Ensure your Tetra 3 unit is switched on and in normal operation.
2. Clip the flow plate onto the front of the unit and attach the hose from the Trigger regulator.
Attach the outlet hose to 'vent gas away' - do not extend this hose and do not restrict or allow kinks.
3. Swipe the magnet over the bubble label on the front of the unit, near the main button. Your Tetra 3 will begin the Gas Test and show 'BUMP TEST' on the display. A countdown progress bar will also appear at the bottom of the display.
4. Operate the Trigger regulator and apply gas to the Tetra 3 whilst the progress bar is counting down.

5. Wait for the progress bar to complete (typically 30-45 seconds). A pass or fail message will appear. To continue using the instrument, disconnect the test gas and press the main button. This will return the unit to its normal operating mode. (The unit is comparing what it measures from the bottle with the standard gas values it knows should be in the bottle.)

6.3 How to perform a field calibration test

To perform a field calibration test, you must first Zero your Tetra 3 unit 15 minutes or less before commencing the gas test instructions.

1. Follow steps 1 to 3 given in 6.2, Tetra 3 will display an alternate screen message;

**Calibrate?
Click to
Confirm
In 10 seconds**

Press the button within 10 seconds to confirm Calibration.

If the button confirmation for calibration is not made within 10 seconds then the process will revert to gas test as in 6.2.

3. Apply calibration gas following step 4 in 6.2.

Tetra 3 will display a progress bar at the bottom, the names of the gas sensors fitted are shown in reverse image with a cross beside each.

Operate the Trigger regulator and apply gas to the Tetra 3 whilst the progress bar is counting down.

As gas flows the Tetra 3 allows the sensors to respond and then adjust the value for each gas channel to match the stored calibration gas value within each sensor i-module. Provided all channels calibrate successfully within the allowed time the calibration will be designated successful. If any channel does not calibrate successfully it will remain marked with a cross and screen a message 'Gas test failed' and 'Send for calibration' will be displayed. A tick will appear against each channel as the unit passes the test

4. To abort the Calibration test press the button at any time whilst the test is in progress.

6.4 Cal/Test

This can arise if having selected and confirmed calibration, one or more (but not all) of the sensors are not calibrate-enabled. In this case calibrate-enabled channels will calibrate, and non-enabled channels will Gas Test (bump) only.

Oxygen sensors are by default not calibrate-enabled, as they are calibrated to 20.9% in fresh air in Zeroing.

6.5 Gas test/calibration troubleshooting

Symptom	Possible Cause	Action
No response to gas	Gas cylinder empty	Check gauge, replace cylinder as needed
	Hose blocked or kinked	Ensure no restriction to flow
Tetra 3 fails gas test	Gas cylinder empty	Check gauge, replace cylinder as needed
	Gas cylinder out of date	Check date and replace as needed
	Hose blocked or kinked	Ensure no restriction to flow
	Calibration drifted	Calibrate Tetra 3
	Gas flow not started immediately	Repeat test, starting gas immediately
Tetra 3 fails calibration	Gas cylinder empty	Check gauge replace bottle as needed
	Gas cylinder out of date	Check date and replace as needed
	Hose blocked or kinked	Ensure no restriction to flow
	Calibration drifted	Calibrate Tetra 3
	Stabilization time too short	Reset using PC software
Tetra 3 passes gas test but will not enter calibration mode	Menu Zero not performed Field calibration not enabled in Tetra 3 unit.	Select Zero from menu Send for re-configuration

Note: Remove regulator from gas cylinder when not in use over a prolonged period.

For parts list, see section XI.

VII. Maintenance and Calibration

Tetra 3 is designed to operate almost maintenance free under most conditions. However, some small items of routine maintenance are recommended.

General

To keep the display panel and operator button free from dirt build up, regularly wipe over your Tetra 3 unit with a damp cloth.

Before opening the instrument case to change any internal components, it is essential to take precautions to ensure ESD protection

Zero and calibration

Tetra 3 is supplied with an auto zero function on start-up. This function can be configured to operate automatically, on user confirmation (see quick start guide), or can be disabled. This configuration can be set with the Crowcon Portables PC software, see section VIII. Tetra 3 also has a zero function in the menu. See section II, item 2.4.

Crowcon recommends, as a minimum, a monthly gas test to confirm sensor operation. A test gas of known composition, needs to be applied, to verify sensor response and alarm function.

Instrument calibration of all sensors should be performed at regular 6 monthly intervals.

Calibration method

Tetra 3 calibration can either be performed using the Portables PC software or by use of the Gas Test Accessory Kit. Using the Portables PC software allows calibration using either single gas mixtures, and calibrating each sensor in turn, or using a multigas mixture for simultaneous calibration. The Gas Test Accessory Kit allows calibration on a quad gas mixture for the standard 4 gas combinations of flammable, oxygen, carbon monoxide and hydrogen sulphide.

VIII. PC interface and software

Tetra 3 can be connected to a PC using the single way charger unit with optional PC interface. The charger unit is fitted with a D-type 9 pin male RS232 socket which is located at the rear of the charger, see diagram below. The PC requires Crowcon Portables PC software. A USB-RS232 adapter is also available from Crowcon.

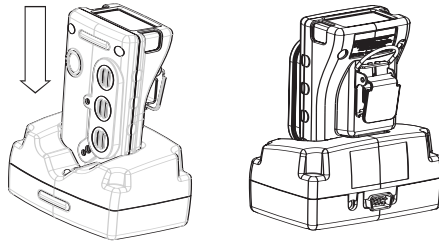

The software provides the user with access to reconfigure alarm levels, operation, run calibrations, print reports and to access data and event log files.

Set-up

1. Install Portables PC software on PC and attach the RS232 cable to the charger and PC.
2. Switch on the Tetra 3 unit and drop it into the charger unit ensuring it is upright and the display is facing forward.
3. Open the Portables PC software and either use the Wizard or the Engineer's Form, select Tetra 3 and upload the configuration.

For more information on using the Crowcon Portables PC software, see installed help file.

IX. i-module replacement

1. Ensure you are in a non-hazardous (safe) area.
Switch off the unit
2. Remove any accessories, such as the flow adaptor, if fitted.
3. Remove the cover by unscrewing the four M3 screws as shown in the drawing, point ①

With care, withdraw the battery with plastic holder downwards.

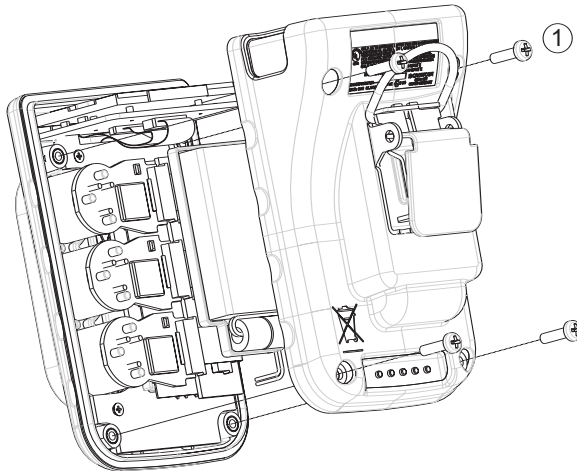

Removing an installed i-module

1. Locate the i-module connection ribbon, squeeze the two retaining lugs, on the i-module board, toward each other and pull out slightly, this will release the ribbon.
2. Gently pull the i-module out of the unit. There may be some resistance at first, as the seal between the sensor and the front case is broken.

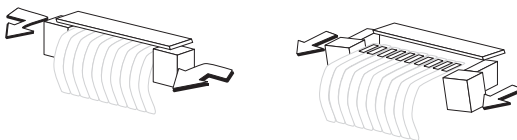

Installing or replacing an i-module

If replacing an i-module with one of the same type, instrument specific configuration will be retained. If replacing with a different i-module its default configuration will be loaded.

1. Unwrap the i-module from any packaging.
If you are installing a new i-module into a currently unused slot, you will first need to remove the dummy i-module. Follow the i-module removal instructions to do so.
2. Ensure the gasket is in place in the sensor. Place the new sensor in the vacant space and push down gently.
3. Attach the ribbon connector by squeezing the two retaining lugs, on the module board, toward each other and pulling out slightly. Slide the ribbon into the slot. Push the retaining lugs back toward the sensor, this will grip the ribbon firmly.
4. If using a dual sensor, always place this in the slot nearest to the display.

Warning

Do not twist the connection ribbons.

Do not pull the i-modules too far from the PCB board, to prevent damage to the cabling or electrical connections

Re-assembling the Tetra 3 unit

1. Ensure that all i-modules are seated in their correct positions and all ribbon cables are folded neatly between the i-modules and the main unit. Put the battery and plastic holder back into their original positions.
2. Switch on your Tetra 3 unit. The new sensor will be automatically identified.

Check the filters and gaskets are all in good condition.

Replace if any items are faulty.

Refer to the troubleshooting guide if necessary.

X. Specification

Dimensions	71 x 114 x 48 mm (2.8 x 4.5 x 1.9 inches)
Weight	295 g unit, including pocket clip and 3 sensors.
Housing, degree of protection	Ingress protection IP65 IP67
Operating temperature	-20°C to +55°C (-4°F to +131°F)
Humidity	0-99% RH, non-condensing for continuous operation
Display	128 x 64 pixel
Warm up time	45 seconds approximately
Response time (typical)	(T90) : appx 20 seconds for most toxic sensors, 10 seconds for oxygen.
Repeatability	±2% FSD, 6 months
Explosion protection	Intrinsically Safe
ATEX	Essential Health and Safety Requirement, clause 15.9
Safety certificate no.	Baseefa05ATEX0187 IECEX BAS05.0037
Approval codes	
Europe:	ATEX II 2G EEx ia d IIC T4, (Tamb -20°C to +55°C)
USA:	Class 1 Division I Groups A, B, C, D.
Canada:	Class 1 Division I Groups A, B, C, D.
Standards	
Safety:	EN50014, EN50020, EN50018, 94/9/EC
USA:	UL913
Canada:	CSA22.2, 152
Operation	EN50270, EN50271

XI. Accessories and spare parts

Accessory list

Crowcon

part number Description

S011952	Aspirator assembly
C011062	Tetra 3 gas test accessory kit
C03327	Quad gas mixture for gas test accessory kit, 34 litre bottle 50%LEL methane, 250ppm carbon monoxide, 15ppm hydrogen sulphide, 18% oxygen balance nitrogen.

For calibration gas contact Crowcon, as the required gases depend upon your sensor combination.

Single way chargers

C011018	12 V DC input single way charger
C011020	Single way charger with 230 V UK style power supply
C011021	Single way charger with 230 V EUR style power supply
C011022	Single way charger with 110 V US style power supply
C011023	Single way charger with 90-260 V inline power supply
C011035	Single way charger with 230 V inline power supply
C011036	Single way charger with 110 V inline power supply
C01296	Vehicle lighter socket lead
C011019	Single way combined charger and PC interface
C011024	Single way charger/interface with 230 V UK style power supply
C011025	Single way charger/interface with 230 V EUR style power supply
C011026	Single way charger/ interface with 110 V US style power supply
C011027	Single way charger/interface with 90-260 V inline power supply
C011037	Single way charger/interface with 230 V inline power supply
C011038	Single way charger/interface with 110 V inline power supply

i-modules:

S011424	0-100% LEL methane
S011436	0-100% LEL propane
S011437	0-100% LEL pentane
S011439	0-100% LEL butane
S011440	0-100% LEL ethylene
S011423	0-25% oxygen O ₂
S011421	0-100ppm hydrogen sulphide H ₂ S
S011422	0-500ppm carbon monoxide CO
S011953M	0-50ppm H ₂ S/0-500ppm CO dual i-module.

*There are alternative combustible sensors for different applications. Contact Crowcon with the instrument serial number to check correct sensor type.

Sampling accessories:

S011952	Aspirator plate
M04897	Aspirator plate and gasket
C01757	Telescopic aspirator probe
C01097	3 foot sample probe
M04032	Aspirator hose (please specify length in feet)
C03328	6 m drop line
C01245	Water trap

Carrying and wearing:

C01952	Universal harness plate
C01843	Shoulder strap
C01844	Chest harness strap kit

Communications:

E07532	PC interface head
C02097	USB to RS232 adaptor
C01832	Portables PC software CD

Spares / consumables:

S011960	Rechargeable Li-ion battery pack assembly
C01851	Aspirator bulb
C01853	Dummy sensor module
M04482	i-module O-ring seal

XII. Troubleshooting guide

Symptom/ error message	Cause	Action
Instrument won't switch on	Flat battery.	Recharge or replace battery.
No confidence beep	Function disabled.	Reconfigure with PC software.
Gas reading when no gas present	Zero drifted.	Restart instrument in clean air.
Unstable/inaccurate gas reading	Sensor failure	Do not use; exit hazardous area immediately. Return instrument for recalibration or sensor replacement.
Auto zero failed	Zeroing in contaminated atmosphere	Switch off and restart in clean air.
Cannot Auto zero due to alarm	Zeroing in contaminated atmosphere	Switch off and restart in clean air
Calibration expired	The calibration due date has passed	Send for calibration
LCD too faint/dark	Contrast setting wrong	Adjust using Portables PC software.



Fatal/Auto shut



Service



User alert



Calibration



Configuration

Appendix: Limitations of sensors

Sensor limitations

The sensors used in Tetra 3 have limitations common to all such gas sensors, and users should be aware of the points listed below. Crowcon can advise on particular situations and suggest alternative sensors if the instrument is likely to experience extreme conditions.

Tetra 3 uses a catalytic combustible gas sensor, which measures the combustibility of the gas. For this reason, readings displayed on the unit will be unreliable over concentrations of approximately 120% LEL. Oxygen is necessary for catalytic sensors to operate. A 'catalytic bead saver' is used to disconnect power to the catalytic bead sensor in the event of over-range to prevent burn out. This locks out for 200 seconds after which a button press will reconnect power to the catalytic bead. If the sensor power is reconnected when the unit is exposed to an over-range gas concentration there is a risk of damage to the catalytic bead sensor. Restart should be carried out in a known fresh air environment. Depleted oxygen levels can reduce the combustible gas reading, and if oxygen levels are below safe breathing limits it should be assumed that the combustible reading is low.

Electrochemical gas sensors contain chemicals. Extreme levels of humidity can also cause problems. The sensors are rated for an (average) ambient of 15-90% R.H. However they are used from the tropics to deserts to tundra without this normally being a problem.

Water should not be allowed to collect on the sensors as this may impede gas diffusion.

Persistent exposure to high levels of toxic gas will shorten the life of toxic sensors. If the high level gas is corrosive (e.g. hydrogen sulphide) damage may occur over time to metal components.

Sensors may be cross sensitive to other gases. If unsure, contact Crowcon or your local agent.



UK Office

Crowcon Detection Instruments Ltd
2 Blacklands Way,
Abingdon Business Park
Abingdon
Oxfordshire OX14 1DY
United Kingdom
Tel: +44 (0)1235 557700
Fax: +44 (0)1235 557749
Email: crowcon@crowcon.com
Web site: www.crowcon.com

Rotterdam Office

Crowcon Detection Instruments Ltd
Vlambloem 129
3068JG, Rotterdam
Netherlands
Tel: +31 10 421 1232
Fax: +31 10 421 0542
Email: eu@crowcon.com
Web site: www.crowcon.com

USA Office

Crowcon Detection Instruments Ltd
21 Kenton Lands Road,
Erlanger,
Kentucky 41018-1845
USA
Tel: +1 800 527 6926 or
1-800-5-CROWCON
+1 859 957 1039
Fax: +1 859 957 1044
Email: salesusa@crowcon.com
Web site: www.crowcon.com

Singapore Office

Crowcon Detection Instruments Ltd
Block 192 Pandan Loop
#05-01 Pantech Industrial Complex
Singapore 128381
Tel: +65 6745 2936
Fax: +65 6745 0467
Email: sales@crowcon.com.sg
Web site: www.crowcon.com